

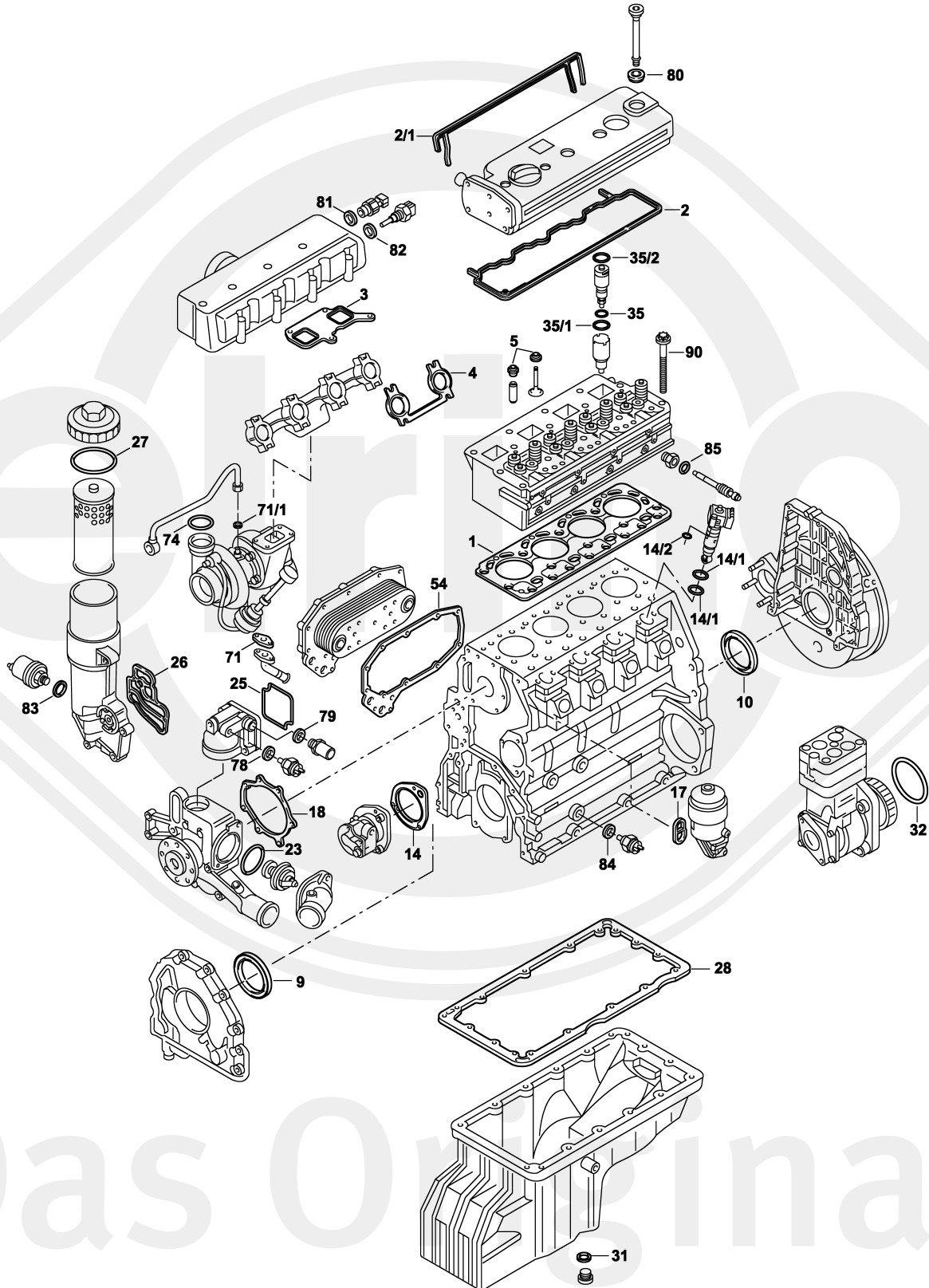

Das Original

Mercedes-Benz









OM 924 LA



Das Original



924.910-917 | 919 | 920 | 922-925 | 927-933

						
S ⊕ *	539.182	1x	-	-	-	
ES	152.454	1x	924 010 26 20 +904 016 07 21	-	-	
CS *	413.700	1x	904 010 45 05	-	-	
SZ	066.450	1x	906 017 02 60	-	-	incl. 000.230/074.870/124.870
SZ	690.240	1x	906 017 08 60	-	-	incl. 000.230/074.870/835.160
ZKHS	136.960	1x	-	-	-	-
ZKS	060.350	1x	906 016 07 69 (10x)	M16x2x149	-	-
LPS	151.450	1x	000 130 68 15	238 ccm   352 ccm	-	Wabco 411 151 003 0   411 154 000 0   906 130 11 15/906 130 12 15
WPS	397.350	1x	-	-	-	incl. 397.280
1	353.512	1x	924 016 11 20	∅ 107,5 mm   $\pm 1,20$ mm	-	-
2	074.800	1x	000 016 04 21	-	-	-
2/1	213.080	1x	904 016 07 21	-	-	-
3	402.001	2x	906 141 01 80	Metaloseal	-	-
3	489.870	4x	904 141 02 80	FPM	-	-
4	412.603	2x	906 142 02 80	-	-	-
5	104.380	12x	906 053 03 58	8x12/15,4x9,5 FPM	-	-
9	445.591	1x	022 997 76 47	78x104x11 AW/BS RD PTFE	-	-
10	445.600	1x	021 997 53 47	115x140x13 AW/B RD PTFE	-	-
10	354.090	1x	025 997 50 47	115x140x12 ASW LD PTFE/ACM	-	-
14	002.070	1x	906 091 05 80	-	-	-
14/1	447.011	4x	028 997 56 48	37,8x2,62 FPM RD		
14/1	356.280	4x	028 997 56 48	36x2,62 FPM RD		
14/2	447.020	4x	023 997 68 48	9x2,5 FPM RD	-	-
17	445.650	1x	002 094 15 80	-	-	-
18	201.091	1x	906 201 00 80	EWP/soft material	-	-
18	397.280	1x	014 997 28 45	Elastomer/Rubber/Caoutchouc/ Goma	-	-
23	495.980	1x	024 997 28 48	EPDM	-	-



924.910-917 | 919 | 920 | 922-925 | 927-933

			#	  	
25	476.220	1x	906 203 01 80	-	
26	445.350	1x	906 184 02 80	-	-
27	147.760	1x	019 997 36 48	91x4 ACM RD	-
28	211.570	1x	904 014 06 22	-	 924.910/912/914/919
28	-	1x	904 014 08 22	-	 924.916
28	074.950	1x	904 014 07 22	ACM PR	 924.911
29		1x	906 997 00 45	-	-
31	133.400	1x	007603 026101	26x32x2 CU A	-
32	447.030	1x	024 997 21 48	118x3 ACM RD	-
35	124.870	4x	906 017 02 60	7x15,1x1,5 CU PR	 924.910/912/914
35	535.160	4x	906 017 06 60	7x14,9x17,4 CU PR	 924.911/915-917/919/920/922-924
35/1	074.870	4x	541 997 07 45	25x3,7 FPM RD	-
35/2	000.230	4x	541 997 05 45	20,9x3 FPM RD	-
54	445.360	1x	904 188 02 80	-	-
54/1	717.460	1x	000 188 32 80	-	-
71	756.866	1x	442 187 00 80	EWP/soft material	-
71	527.090	1x	541 187 00 80	Metaloseal	-
71/1	207.351	1x	904 187 00 80	-	-
74	268.402	1x	028 997 63 48	44x4 FPM RD	-
78	115.100	1x	007603 014106	14x20x1,5 CU A	-
79	125.105	1x	007603 020103	20x26x1,5 CU A	-
80	074.820	5x	000 016 00 40	-	-
81	125.105	1x	007603 020103	20x26x1,5 CU A	-
82	243.205	1x	007603 014104	14x20x1,5 AL A	-
83	805.020	1x	000000 001072	20x26x1,5 CU/ZNN A	-
84	804.980	1x	000000 001069	14x20x1,5 CU/ZNN A	-
85	761.559	4x	541 997 06 45	11x3 FPM RD	-
90	060.350	1x	906 016 07 69	M16x2x149	-